



# C Series Coaxial Connectors

ONLINE CATALOG

## Contents

CLICK ON ANY LINE TO GO DIRECTLY TO THE INDICATED PAGE

Navigation Guide . . . . .	2
Specifications and interface dimensions. . . . .	3
Design Features . . . . .	4
<hr/>	
<b>Cable Connectors</b>	
Straight Cable Plugs. . . . .	5
Right Angle Cable Plugs. . . . .	5
Straight Cable Jacks . . . . .	6
Bulkhead Cable Jacks . . . . .	6
Panel Cable Jacks . . . . .	7
<b>Receptacles</b>	
Panel Jack Receptacles . . . . .	7
Panel Plug Receptacles. . . . .	8
Bulkhead Jack Receptacles . . . . .	8
<b>Accessories</b>	
In-Series Adapters . . . . .	9
Dust Caps. . . . .	9
<b>Technical Information</b>	
Mounting Figures. . . . .	10
Cable Groups . . . . .	11
Cable Assembly Instructions. . . . .	12
Ordering and Warranty . . . . .	13

We have configured this online catalog to take advantage of Acrobat navigation shortcuts (links). However, these links are not visible on the pages— making them visible would compromise the page’s readability.

- Clicking on any entry in the Table of Contents will take you to the indicated page.
- Shown below are the “hot spots” on all of the product pages that will take you to background information on various connector characteristics.
- After you use a link to jump to another page, you can use the “back” arrow in Acrobat’s menu bar to return to the page you jumped from.
- Configure Acrobat Reader to show bookmarks for a table of contents by specific characteristic (for example, cable plugs broken out by cable attachment method).
- To find a specific part number, use Acrobat’s search feature.

In addition, the pages are formatted to fit within the margins of standard laser or inkjet printers—no need to use the “shrink to fit” option when printing pages from Acrobat.

Click [here](#) to go to the Table of Contents

Click on the Delta logo on any page to jump to the table of contents.

Click on the page title to jump to specifications and interface dimensions.

## BNC Cable Jacks

### Panel Jack—Military Clamp for Flexible Cable

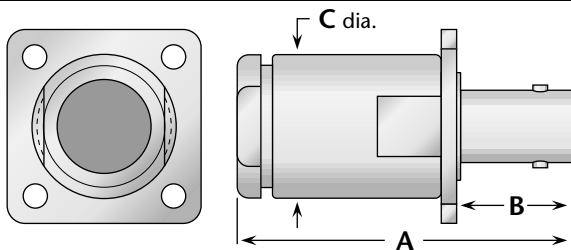


Figure 1

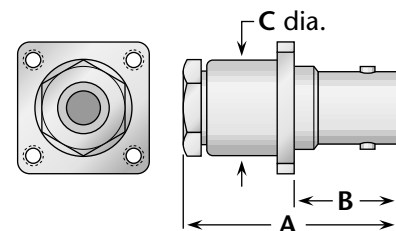


Figure 2

Cable Group	Fig.	Dimensions			Mounting Figure	Plating		Delta P/N	Assembly Procedure/Trim Code
		A	B	C		Body	Contact		
1	1	1.75	.63	.75	33	Nickel	Silver	1011-001-N330	A/20
2, 3	1	1.75	.63	.75	33	Nickel	Silver	1011-004-N330	A/20
5, 6	2	1.16	.55	.50	07	Nickel	Silver	UG-291C/U	A/17

Click here to jump to dimensions for Delta mounting figures.

Click here to jump to the cable assembly procedure for this connector.

Click here to jump to information on alternate body plating.

Click here to jump to a guide to Delta cable groups.

Click here to go to Delta’s website if your computer is configured for Web connection via Acrobat.

## General Description

Delta C series connectors are medium-size, 50Ω impedance connectors with two-stud bayonet coupling and good power handling capability, particularly those connectors noted as high-voltage types. They are best suited for use with cables in the range of .350" to .450" diameter, but are available for other cables from .100" to over 1" diameter. Our extensive line of C receptacles includes configurations for virtually any packaging requirement, and we can supply any adapter or accessory you need to complete your system design.

As with our other connector series, Delta's *customer-driven design* results in C series connectors with practical and unique features that make your design and assembly process easier. Some of these include:

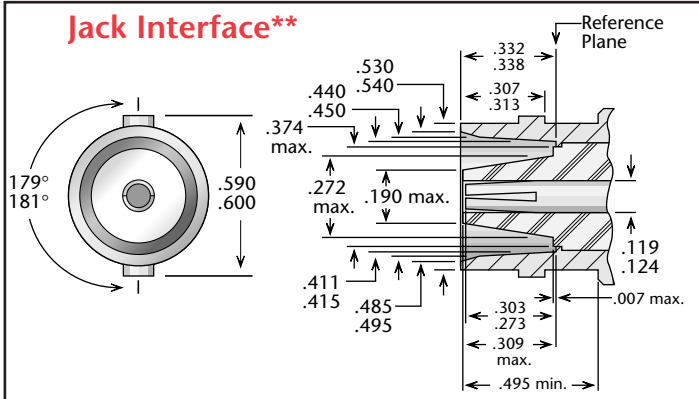
- High-voltage types for high-power applications.
- Cable plugs and jacks for armored cables.

Our C series product line is still growing, so please call if you don't see what you need.

**For adapters between C and other series, download the document *DeltaABS.pdf* from our website.**

## C Specifications\*

### Jack Interface\*\*



### Electrical:

**Nominal Impedance:** 50 ohms.

**Frequency Range:** DC-11 GHz (standard);  
DC-2 GHz (high-voltage).

**Voltage Rating:** 1,000 volts RMS (standard);  
3,000 volts RMS (high-voltage).

**Dielectric Withstanding Voltage:** 3,000 VRMS.

**Insulation Resistance:** 5,000 megohms.

### Materials/Finishes:

**Insulators:** Teflon per ASTM-D-1710.

**Male Contacts:** Brass per ASTM-B-16.

**Female Contacts:** Beryllium Copper per  
ASTM-B-196.

**Contact Plating:** Silver per QQ-S-365, or  
Gold per MIL-G-45204.

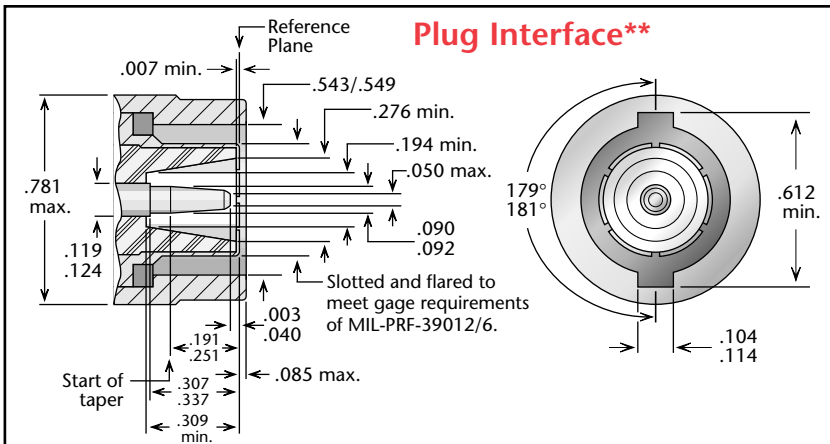
**Gaskets:** Silicone rubber per ZZ-R-765,  
Class II, Grade 50.

**Other Metal Parts:** Brass per ASTM-B-16,  
plated:  
Silver per QQ-S-365, or  
Nickel per QQ-N-290.

All other specifications are in accordance with the latest issues of MIL-PRF-39012, or MIL-A-55339, or other applicable MIL specifications, and interfaces are in accordance with MIL-STD-348.

\*These specifications are typical and may not apply to all connectors. Detailed specifications for individual connectors are available on request.

### Plug Interface\*\*



\*\*Some proportions altered to illustrate detail.

### About Delta's Customer-Driven Design

At Delta, *Customer-Driven Design* isn't just a catchy slogan. It means that we make RF connectors that help you build your products efficiently, quickly, and cost-effectively. Because we design for *your* needs, nobody else can offer you such a broad line of standard connectors, along with an ever-growing list of innovative, user-friendly design variations like those detailed on these pages.

These featured connector technologies grew out of real-world requirements, and have saved our customers untold hours and dollars over the years. And there are thousands of other special connector designs we've produced that we don't have space to include in this catalog. So if you don't see the exact connector configuration you need, please call us—we may have already made it. If not, we'll work with you to provide the the connectors you need, with the best price/performance balance in the business, and with quality and delivery that will enhance your products and production schedules.

### Plating Options for Economy and Performance

(Albaloy or nickel—available for all connector series except SMA)

Silver plating has long been standard on RF connectors with brass bodies, but its high cost and low corrosion resistance make it less than ideal in most applications. Nickel plating is less expensive and more durable than silver, and is standard on many of our connectors.

However, in some applications, nickel plating can introduce unwanted intermodulation distortion, particularly on large size connectors. For these applications, we offer optional Albaloy plating, a tin/zinc/copper composite with a bright white finish, the corrosion resistance of nickel, and the low intermodulation distortion of silver plating.

Albaloy plating has the same composition as, and is fully compatible with, other commercial platings designated Sucoplate<sup>®</sup>, IP-23, White Bronze, and Tri-Alloy.

To order a Delta connector with plating other than the listed finish, substitute **A**, **N**, or **Q** in the Delta part number as below:

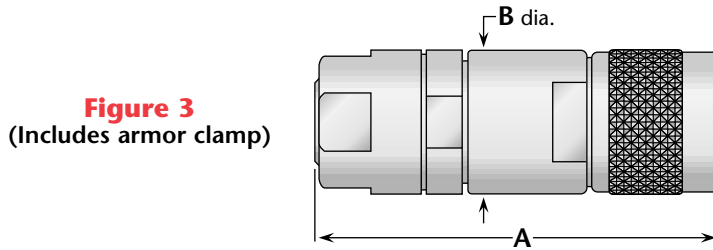
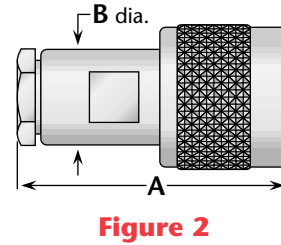
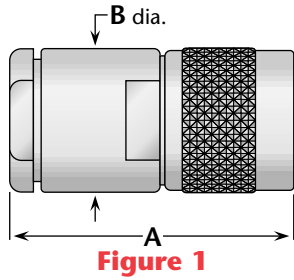
For **silver** plating: 1111-111-**A**111.

For **nickel** plating: 1111-111-**N**111.

For **Albaloy** plating: 1111-111-**Q**111.

**Note:** M39012 and M55339 QPL connectors can only be supplied with the specified plating. SMA connectors with stainless-steel bodies are available with gold plating or passivated finish.

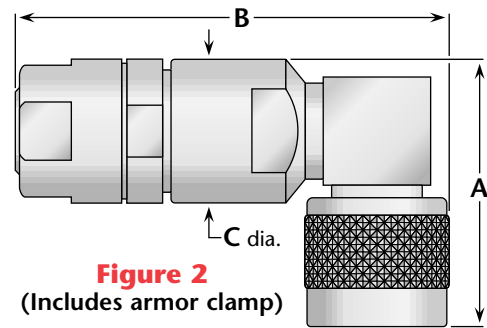
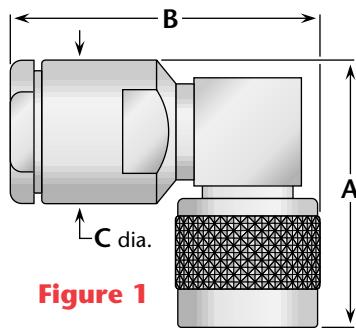
## Straight Plug—Military Clamp for Flexible Cable



Cable Group	Figure	Dimensions		Plating		Delta P/N	Assembly Procedure/ Trim Code
		A	B	Body	Contact		
1	1	1.50	.75	Nickel	Silver	UG-626B/U	A/20
2, 3	1	1.50	.75	Nickel	Silver	UG-573B/U	A/20
2, 3	1	1.72	.75	Nickel	Silver	UG-628A/U*	A/21
2, 3	1	1.50	.75	Nickel	Silver (C)	1401-004-N001	A/01
5, 6	2	1.36	.50	Nickel	Silver	UG-709B/U	A/13
5, 6	2	1.36	.50	Nickel	Silver (C)	1401-015-N001	A/02
7	2	1.36	.50	Nickel	Silver	UG-627B/U	A/22
15	3	2.13	.75	Nickel	Silver	UG-943B/U	D/04
16	1	1.63	.88	Nickel	Silver	UG-707A/U	A/23

\* High-voltage type.

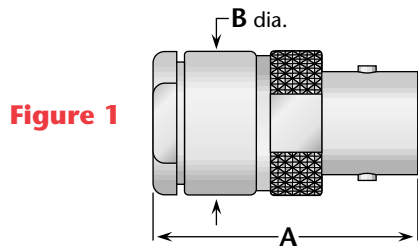
## Right Angle Plug—Military Clamp for Flexible Cable



Cable Group	Figure	Dimensions			Plating		Delta P/N	Assembly Procedure/ Trim Code
		A	B	C	Body	Contact		
2, 3	1	1.35	1.62	.75	Nickel	Gold	UG-710B/U	A/07
2, 3	1	1.35	1.62	.75	Nickel	Silver (C)	1404-004-N001	A/01
15	2	1.35	2.31	.75	Nickel	Silver	UG-945B/U	D/01
16	1	1.41	1.78	.88	Nickel	Silver	1404-007-N000	A/24

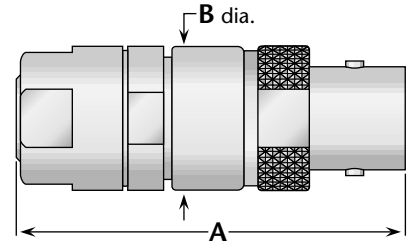
(C) in contact plating column indicates captive contact.

## Straight Jack—Military Clamp for Flexible Cable



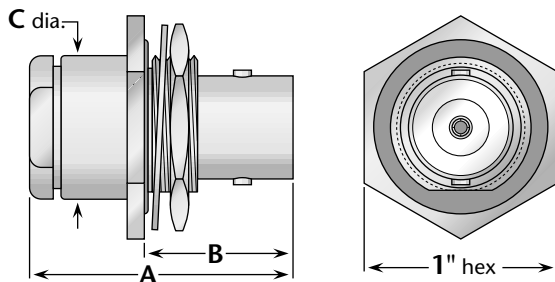
**Figure 1**

**Figure 2**  
(Includes armor clamp)

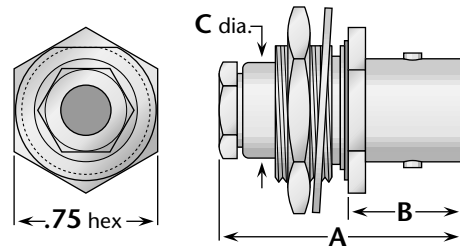


Cable Group	Figure	Dimensions		Plating		Delta P/N	Assembly Procedure/ Trim Code
		A	B	Body	Contact		
1	1	1.41	.75	Nickel	Silver	UG-633A/U	A/20
2, 3	1	1.41	.75	Nickel	Silver	UG-572A/U	A/20
2, 3	1	1.41	.75	Nickel	Silver (C)	1408-004-N001	A/01
15	2	2.00	.75	Nickel	Silver	UG-944A/U	D/04

## Bulkhead Jack—Military Clamp for Flexible Cable

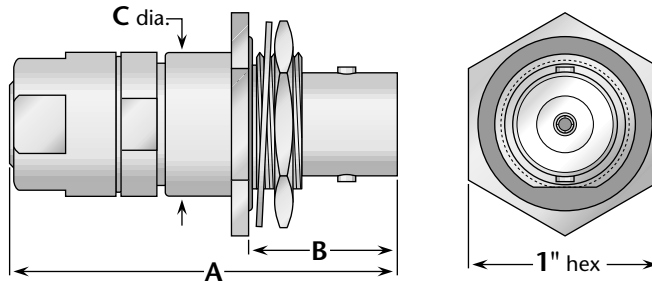


**Figure 1**  
(Rear mount)



**Figure 2**  
(Front mount)

**Figure 3**  
(Rear mount;  
Includes armor clamp)

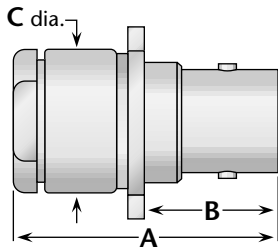


Cable Group	Fig.	Dimensions			Mounting Figure	Max. Panel	Plating		Delta P/N	Assembly Procedure/ Trim Code
		A	B	C			Body	Contact		
1	1	1.41	.75	.75	51	.125	Nickel	Silver	UG-630A/U	A/20
2, 3	1	1.41	.75	.75	51	.125	Nickel	Silver	UG-570A/U	A/20
2, 3	1	1.72	.75	.75	51	.125	Nickel	Silver	UG-632A/U*	A/21
2, 3	1	1.41	.75	.75	51	.125	Nickel	Silver (C)	1416-004-N511	A/01
5, 6	2	1.25	.59	.50	54	.190	Nickel	Silver	UG-704B/U	A/25
7	2	1.25	.59	.50	54	.190	Nickel	Silver	UG-631A/U	A/22
15	3	2.00	.75	.75	51	.125	Nickel	Silver	UG-937A/U	D/04

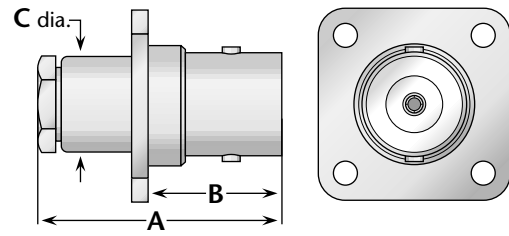
\* High-voltage type.

(C) in contact plating column indicates captive contact.

## Panel Jack—Military Clamp for Flexible Cable

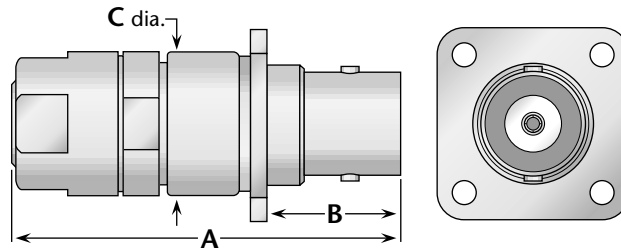


**Figure 1**



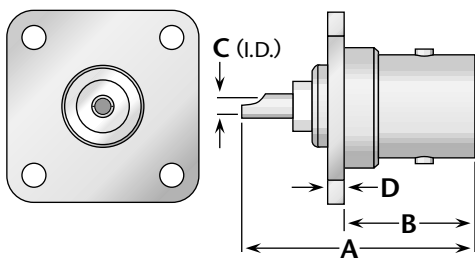
**Figure 2**

**Figure 3**  
(Includes armor clamp)

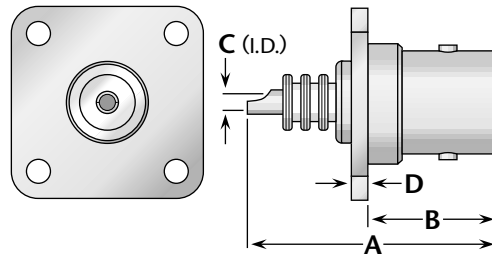


Cable Group	Fig.	Dimensions			Mounting Figure	Plating		Delta P/N	Assembly Procedure/Trim Code
		A	B	C		Body	Contact		
1	1	1.41	.69	.75	26	Nickel	Silver	UG-629A/U	A/20
2, 3	1	1.41	.69	.75	26	Nickel	Silver	UG-571A/U	A/20
2, 3	1	1.41	.69	.75	26	Nickel	Silver (C)	1411-004-N261	A/01
5, 6	2	1.28	.67	.50	26	Nickel	Silver	1411-015-N260	A/25
15	3	2.00	.69	.75	26	Nickel	Silver	UG-938A/U	D/04

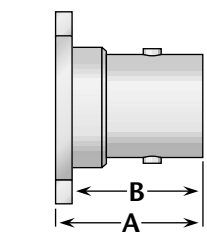
## Panel Jack Receptacle—Square Flange



**Figure 1**  
(Solder pot contact)



**Figure 2**  
(Solder pot contact)



**Figure 3**  
(Dummy receptacle)

Figure	Dimensions				Mounting Figure	Plating		Delta P/N
	A	B	C	D		Body	Contact	
1	1.06	.67	.106	.080	26	Nickel	Silver (C)	UG-568/U
1	1.06	.67	.106	.080	33	Nickel	Silver (C)	1413-000-N331
2	1.31	.67	.106	.080	33	Nickel	Gold (C)	1413-000-N331-1*
3	.740	.080	—	—	33	Nickel	—	1463-000-N330

\* High-voltage type.

(C) in contact plating column indicates captive contact.

**Panel Plug Receptacle—Square Flange**

**Figure 1**  
(Solder pot contact)

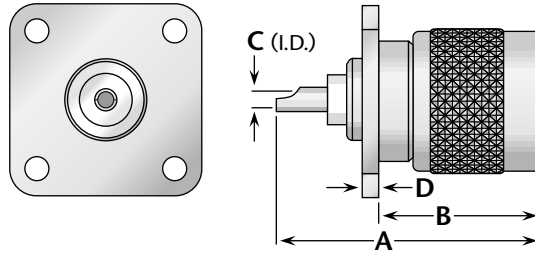
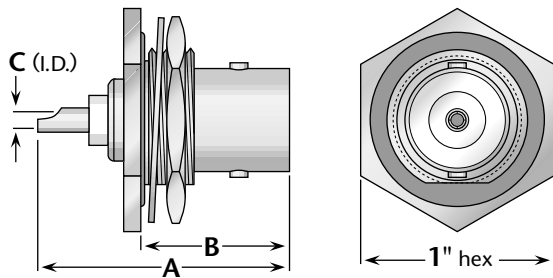
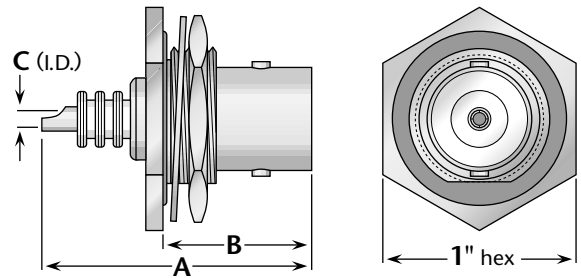


Figure	Dimensions				Mounting Figure	Plating		Delta P/N
	A	B	C	D		Body	Contact	
1	1.09	.83	.106	.080	33	Nickel	Silver (C)	1423-000-N331

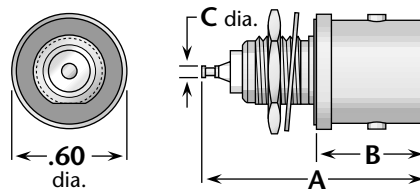
**Bulkhead Jack Receptacles**



**Figure 1**  
(Rear mount, with mounting gasket)



**Figure 2**  
(Rear mount, with mounting gasket)



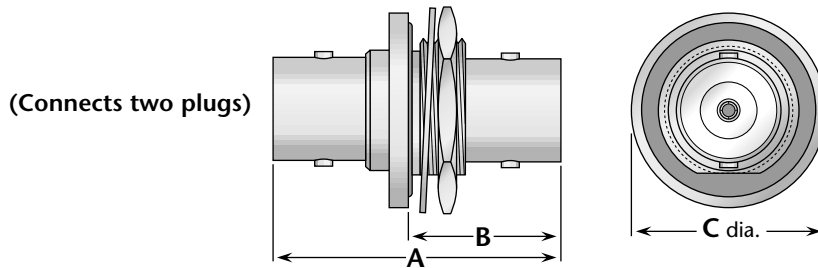
**Figure 3**  
(Front mount, with mounting gasket)

Figure	Dimensions			Max. Panel	Mounting Figure	Plating		Delta P/N
	A	B	C			Body	Contact	
1	1.06	.75	.106	.125	51	Nickel	Silver (C)	UG-569A/U
2	1.32	.75	.106	.125	51	Nickel	Silver (C)	UG-634/U*
3	1.10	.58	.061	.125	65	Nickel	Silver (C)	UG-706A/U

\* High-voltage type.

(C) in contact plating column indicates captive contact.

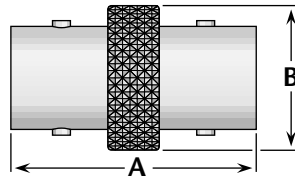
## Bulkhead Jack-Jack Adapter



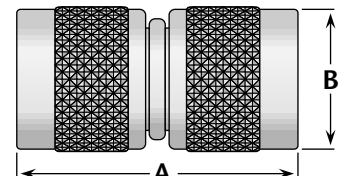
Dimensions			Max. Panel	Mounting Figure	Plating		Delta P/N
A	B	C			Body	Contact	
1.50	.855	1.00	.200	51	Nickel	Silver (C)	UG-1138A/U*
1.50	.855	1.00	.200	51	Nickel	Silver (C)	1426-000-N511

## Straight, Right Angle, and Tee Adapters

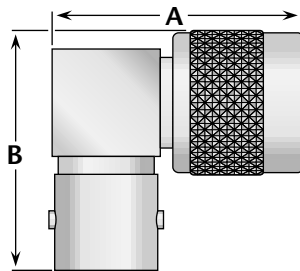
**Figure 1**  
(Straight jack-jack;  
connects two plugs)



**Figure 2**  
(Straight plug-plug;  
connects two jacks)



**Figure 3**  
(Right angle jack-plug;  
connects one plug  
and one jack)



**Figure 4**  
(Tee jack-plug-jack;  
connects two plugs  
and one jack)

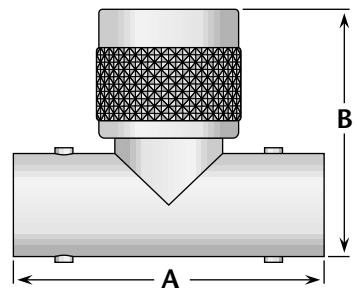
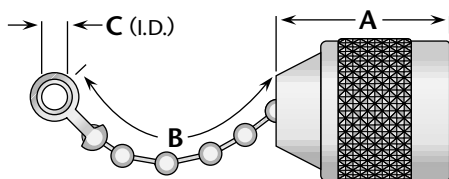


Figure	Dimensions		Plating		Delta P/N
	A	B	Body	Contact	
1	1.28	.75	Nickel	Silver (C)	UG-643/U
2	1.45	.75	Nickel	Silver (C)	UG-642A/U
3	1.25	1.16	Nickel	Silver (C)	UG-567A/U
4	1.52	1.28	Nickel	Silver (C)	UG-566A/U

## Dust Caps

**Figure 1**



**Figure 2**

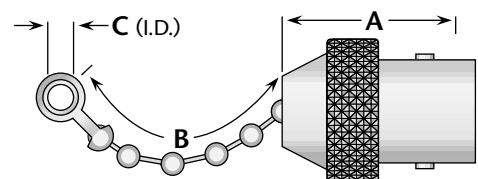
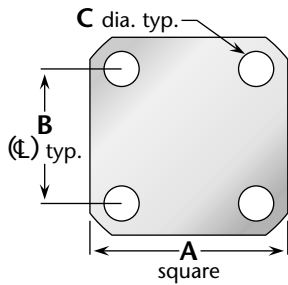


Figure	Dimensions			Features	Plating		Delta P/N
	A	B	C		Body	Contact	
1	.91	2.50	.144	Bead chain	Nickel	—	MX-1142A/U
2	.89	3.50	.144	Bead chain	Nickel	—	MX-1143A/U

(C) in contact plating column indicates captive contact

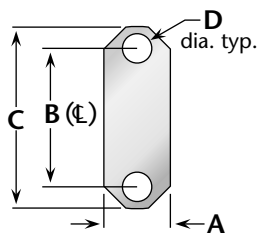
## Connector Flanges (Panel mounted connectors)



### 4-hole flanges

Figure	A	B	C
04	1/2	.360	.089
05	1/2	.340	.102
07	11/16	.500	#3-56 tap
08	11/16	.500	.136
09	11/16	.500	.125
10	11/16	.500	.120
12	11/16	.500	.109
18	3/4	.531	.136
26	1	.718	#6-32 tap
27	1	.718	#4-40 tap
30	1	.718	.166
32	1	.718	.136
32A	1	.718	.136*
33	1	.718	.125
34	13/32	.812	.150
36	13/16	.906	#6-32 tap
39	13/16	.906	.152
40	13/16	.906	.125
45	2	1.437	.257
91	.375	.250	.067
91A	.375	.232	.093

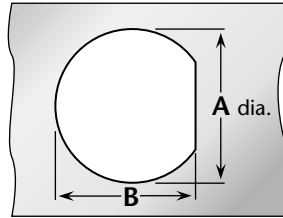
\* Countersunk to .245 dia.



### 2-hole flanges

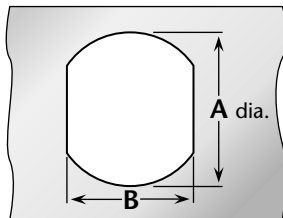
Figure	A	B	C	D
92	.223	.481	.625	.102
92A	.260	.481	.625	.102
95	.640	1.015	1.30	.125

## Panel Cutouts (Bulkhead mounted connectors)



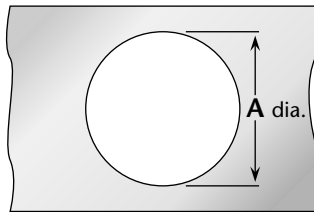
### D-Hole

Figure	A	B
51	.755	.723
54	.630	.598
55	.630	.583
57	.557	.531
59	.505	.473
62	.442	.410
63	.407	.362
65	.380	.348
66	.319	.292
67	.255	.236
68	.195	.176



### Double D-Hole

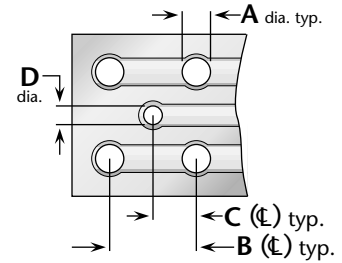
Figure	A	B
69	.755	.692
72	.630	.536
75	.380	.341
84	.319	.278



### Round Hole

Figure	A
82	.255
89	.380

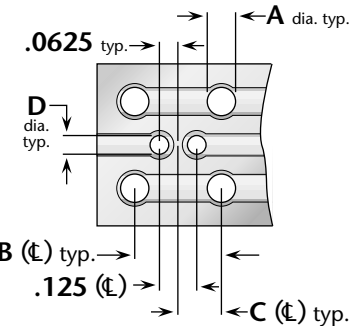
## P.C. Board Drilling



(PCB traces are shown for illustrative purpose only, and are not representative of actual circuitry.)

### Coaxial connectors

Figure	A	B	C	D
PCB01	.067	.400	.200	.045
PCB02	.045	.500	.250	.045
PCB03	.067	.300	.150	.035
PCB05	.067	.200	.100	.055
PCB06	.067	.200	.100	.045



(PCB traces are shown for illustrative purpose only, and are not representative of actual circuitry.)

### Twinax connectors

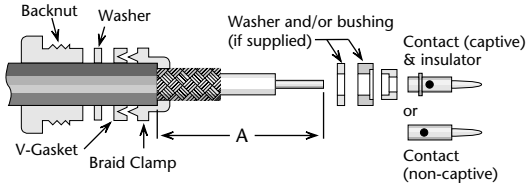
Figure	A	B	C	D
PCB04	.045	.500	.250	.045

<b>Cable Group Finder</b>			
<b>Cable</b>	<b>Group</b>	<b>Cable</b>	<b>Group</b>
RG-5, 5A, B	1A	RG-225	3C
RG-6, 6A	1B	RG-228A	20
RG-8, 8A	2A	RG-302	22
RG-9, 9A, B	3A	RG-303	23
RG-10	15	RG-304	24
RG-11, 11A	2B	RG-316	9A
RG-12	15	RG-316DS	10
RG-13A	3B	RG-393	4
RG-14A	16	RG-400	6A
RG-17A	17	RG-401	12
RG-18A	18	RG-402	13
RG-21, 21A	1A	RG-405	14
RG-22, 22A, B	28	M17/2	1B
RG-55, 55B	6B	M17/6	2B
RG-55A	6A	M17/15	28
RG-58, 58A, C	5	M17/28	5
RG-59, 59A, B	7A	M17/29	7A
RG-62, 62A, B, C	7A	M17/30	7A
RG-71, 71A, B	7B	M17/45	27
RG-108, 108A	27	M17/73	1A
RG-115A	19	M17/162	1A
RG-118A	20	M17/112	1C
RG-122	8A	M17/74	2A
RG-126	21	M17/75	3A
RG-141, 141A	5	M17/127	3C
RG-142, 142A	6A	M17/77	3B
RG-142B	6B	M17/60	6A
RG-143, 143A	1C	M18/84	6A
RG-174	9A	M17/128	6A
RG-174DS	10	M17/97	7A
RG-178, 178A, B	11	M17/54	8A
RG-179A, 179B	9B	M17/95	8B
RG-180, 180A, B	8B	M17/137	8B
RG-187, 187A	9B	M17/152	9A
RG-188, 188A	9A	M17/93	11
RG-195	8B	M17/129	12
RG-196, 196A	11	M17/130	13
RG-210	7A	M17/133	14
RG-212	1C	M17/78	16
RG-213	2A	M17/165	16
RG-214	3A	M17/176	30
RG-215	15	AT&T 735A	31
RG-217	16	Belden 8281	26
RG-218	17	Belden 9207	29
RG-219	18	Dearborn 6207	29
RG-222	1C	IBM 7362211	29
RG-223	6A		

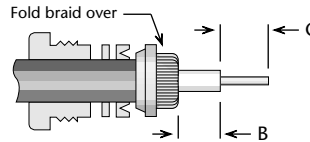
<b>Delta Cable Groups</b>	
<b>Group</b>	<b>Cables</b>
1	1A RG-5, 5A, 5B, 21, 21A; M17/73, /162
	1B RG-6, 6A; M17/2
	1C RG-143, 143A, 212, 222; M17/73, /112, /162
2	2A RG-8, 8A, 213; M17/74
	2B RG-11, 11A; M17/6
3	3A RG-9, 9A, 9B, 214; M17/75
	3B RG-13A, 216; M17/77
	3C RG-225; M17/127
4	RG-393; M17/127
5	RG-58, 58A, 58C, 141, 141A; M17/28, /111
6	6A RG-55A, 142, 142A, 223, 400; M17/60, /84, /128
	6B RG-55, 55B, 142B; M17/60, /84
7	7A RG-59, 59A, 59B, 62, 62A, 62B, 62C, 210; M17/29, /30, /97
	7B RG-71, 71A, 71B; M17/90
8	8A RG-122; M17/54
	8B RG-180, 180A, 180B, 195; M17/95, /137
9	9A RG-174, 188, 188A, 316; M17/152
	9B RG-179A, 179B, 187, 187A; M17/94, /136
10	Double-Shielded RG-174, 316; M17/152
11	RG-178, 178A, 178B, 196, 196A; M17/93
12	.250" semi-rigid; RG-401; M17/129
13	.141" semi-rigid; RG-402; M17/130
14	.085" semi-rigid; RG-405; M17/133
15	RG-10, 12, 215; M17/6, /74
16	RG-14A, 217; M17/78, /165
17	RG-17A, 218
18	RG-18A, 219
19	RG-115A
20	RG-118A, 228A
21	RG-126
22	RG-302
23	RG-303
24	RG-304
25	Special 8X cable; contact factory for details.
26	Belden 8281
27	RG-108, 108A; M17/45
28	RG-22, 22A, 22B; M17/15
29	Belden 9207; Dearborn 6207; IBM 7362211
30	M17/176
31	AT&T 735A

## Assembly Procedure A

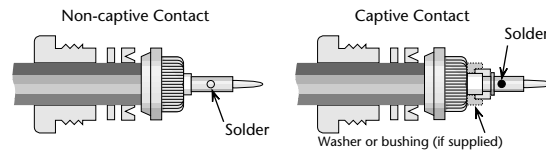
- 1)** Trim cable jacket to dimension A. Slide backnut, washer, V-gasket, and braid clamp onto cable as shown. Cable jacket should bottom on step in braid clamp.



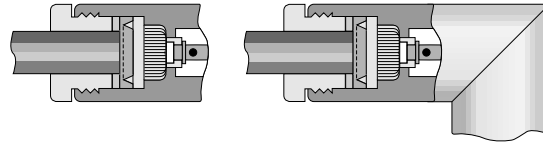
- 2)** Comb braid wires out straight and fold back over front shoulder of braid clamp (braid wires should not overlap one another after folding). Trim braid wires flush with step of braid clamp. Trim cable dielectric and center conductor to dimensions B and C.



- 3)** If support insulator is provided for RG-62 or 71 cable, insert into hollow in dielectric. Assemble rear bushing or washer (if supplied), rear insulator (if captive contact) and contact, and solder contact to center conductor. Rear of contact should be flush with cable dielectric end. For right angle connectors with access cap, omit this step entirely.



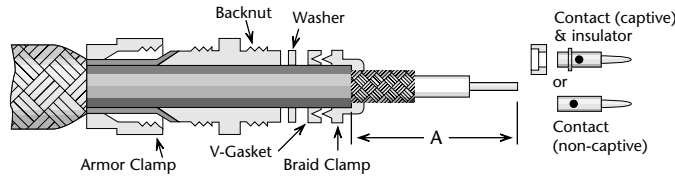
- 4)** Insert prepared cable and hardware into body and tighten backnut. For right angle connectors with access cap, solder center conductor into slot in contact and tighten access cap.



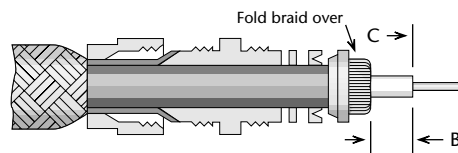
### Trim Codes For Assembly Procedure A

Code	A	B	C	Code	A	B	C
A/01	.375 (3/8)	.047 (3/64)	.203 (13/64)	A/19	.375 (3/8)	.188 (3/16)	.094 (3/32)
A/02	.375 (3/8)	.109 (7/64)	.203 (13/64)	A/20	.375 (3/8)	.047 (3/64)	.172 (11/64)
A/03	.438 (7/16)	.250 (1/4)	.188 (3/16)	A/21	.500 (1/2)	.313 (5/16)	.172 (11/64)
A/04	.281 (9/32)	.047 (3/64)	.125 (1/8)	A/22	.375 (3/8)	.188 (3/16)	.141 (9/64)
A/05	.313 (5/16)	.125 (1/8)	.109 (7/64)	A/23	.438 (7/16)	.078 (5/64)	.172 (11/64)
A/06	.594 (19/32)	.391 (25/64)	.156 (5/32)	A/24	.500 (1/2)	.094 (3/32)	.141 (9/64)
A/07	.375 (3/8)	.047 (3/64)	.125 (1/8)	A/25	.438 (7/16)	.141 (9/64)	.172 (11/64)
A/08	.281 (9/32)	.109 (7/64)	.094 (3/32)	A/26	.625 (5/8)	.281 (9/32)	.250 (1/4)
A/09	.344 (11/32)	.109 (7/64)	.094 (3/32)	A/27	.688 (11/16)	.281 (9/32)	.125 (1/8)
A/10	.406 (13/32)	.109 (7/64)	.203 (13/64)	A/28	.656 (21/32)	.297 (19/64)	.250 (1/4)
A/11	.500 (1/2)	.281 (9/32)	.156 (5/32)	A/29	.688 (11/16)	.125 (1/8)	.313 (5/16)
A/12	.343	.040	.219	A/30	.688 (11/16)	.469 (15/32)	.156 (5/32)
A/13	.375 (3/8)	.125 (1/8)	.156 (5/32)	A/31	.700 (21/32)	.453 (29/64)	.250 (1/4)
A/14	.355	.090	.188 (3/16)	A/32	.313 (5/16)	.078 (5/64)	.188 (3/16)
A/15	.425	.094 (3/32)	.259	A/33	.250 (1/4)	.078 (5/64)	.094 (3/32)
A/16	.328 (21/64)	.094 (3/32)	.188 (3/16)	A/34	.250 (1/4)	.062 (1/16)	.109 (7/64)
A/17	.375 (3/8)	.109 (7/64)	.125 (1/8)	A/35	.837	.575	.150
A/18	.375 (3/8)	.062 (1/16)	.172 (11/64)	A/36	.450	.250	.150

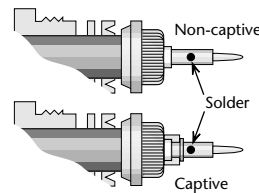
## Assembly Procedure D



**1)** Slide armor clamp over cable. Push armor back to expose cable end. Slide backnut, washer, gasket, and braid clamp onto cable as shown. Cable jacket should bottom on step in braid clamp. Trim cable jacket to dimension A.

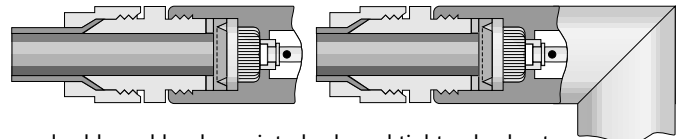


**2)** Comb braid wires out straight and fold back over front shoulder of braid clamp (braid wires should not overlap one another after folding). Trim braid wires flush with edge of braid clamp. Trim cable dielectric and center conductor to dimensions B and C.



**3)** Assemble rear insulator (if captive contact) and contact, and solder contact to center conductor. Rear of contact should be flush with cable dielectric end.

Trim Codes			
Code	A	B	C
D/01	.375 (3/8)	.047 (3/64)	.250 (1/4)
D/02	.500 (1/2)	.188 (3/16)	.219 (7/32)
D/03	.344 (11/32)	.047 (3/64)	.219 (7/32)
D/04	.313 (5/16)	.047 (3/64)	.172 (11/64)
D/05	.625 (5/8)	.281 (9/32)	.250 (1/4)
D/06	.313 (5/16)	.062 (1/16)	.109 (7/64)



**4)** Insert prepared cable and hardware into body and tighten backnut. Trim armor to fit between armor clamp and braid clamp. Tighten armor clamp.

## Ordering and Warranty Information

**Warranty:** We warrant our parts to be free from defects in materials and workmanship for one year from date of purchase. During that time, we will repair or replace (at our option) any parts found to be defective.

This warranty does not apply to parts which have been modified, used in conditions exceeding Delta or military specifications, or disassembled. We will not, under any circumstances, be responsible for consequential or incidental damages or installation costs.

No other warranties apply, and no other liability may be assumed or extended by representatives or distributors.

**Returns:** Returns will be accepted only with a Return Authorization number issued by Delta, and are subject to inspection and acceptance upon arrival. Restocking charges will be determined prior to issuance of Return Authorization.

All claims for shortages must be made within 30 days of receipt by customer.

**Ordering Information:** Orders are subject to the terms and conditions on our order acknowledgement, which may only be modified by written agreement prior to sale. Order changes, cancellation, or termination will be accepted only with written approval from Delta Electronics Manufacturing.

**Copyright, Trademarks, and Patents:** Entire contents copyright 2000, Delta Electronics Manufacturing Corporation. Reproduction rights are hereby granted for, and specifically limited to, printing or other reproduction of drawings and specifications for inclusion in specification or source control drawings, or for purchasing procedures, by Delta customers only. *Heli-Grip*, *PressMount*, and the New England Craftsmanship logo are trademarks. The Heli-Grip design is covered by U.S. and foreign patents.

**Delta Electronics Manufacturing Corporation**

416 Cabot Street, P.O. Box 53

Beverly, MA 01915

FSCM/CAGE 00795

Catalog # Cpdf 1.0